



WinBridge

Voice Amplifier User Manual



S208

Function Illustration

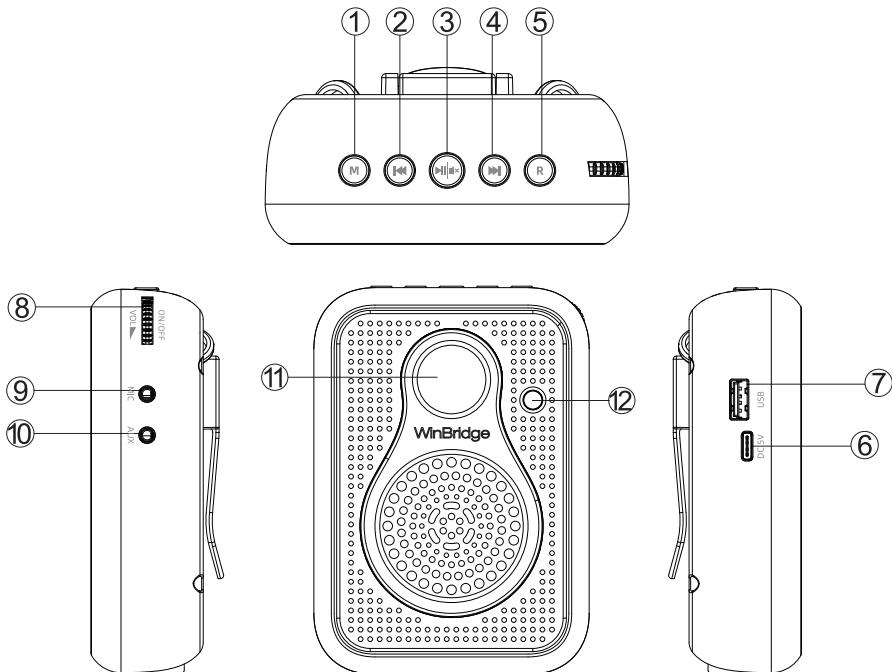

Main Function Description

1. Mode switch
2. Previous song
3. Play / Pause / Mute
4. Next song
5. Recording

6. DC 5V charging slot

7. U Disk slot

8. Power on / Power off / Volume adjustment

9. MIC slot

10. Aux slot

11. Digital display screen

12. Light indicator

Detailed introduction

1. Plug and play

- Turn on speaker with power switch on the side of control panel, and the display shows "HI" then the "BLUE" is displayed. Plug the headset microphone into MIC slot, and then your voice will be amplified.
- When a wired microphone is plugged in any mode, a "MIC" mark will be displayed on the screen.

- You can play music and amplify your voice at the same time.

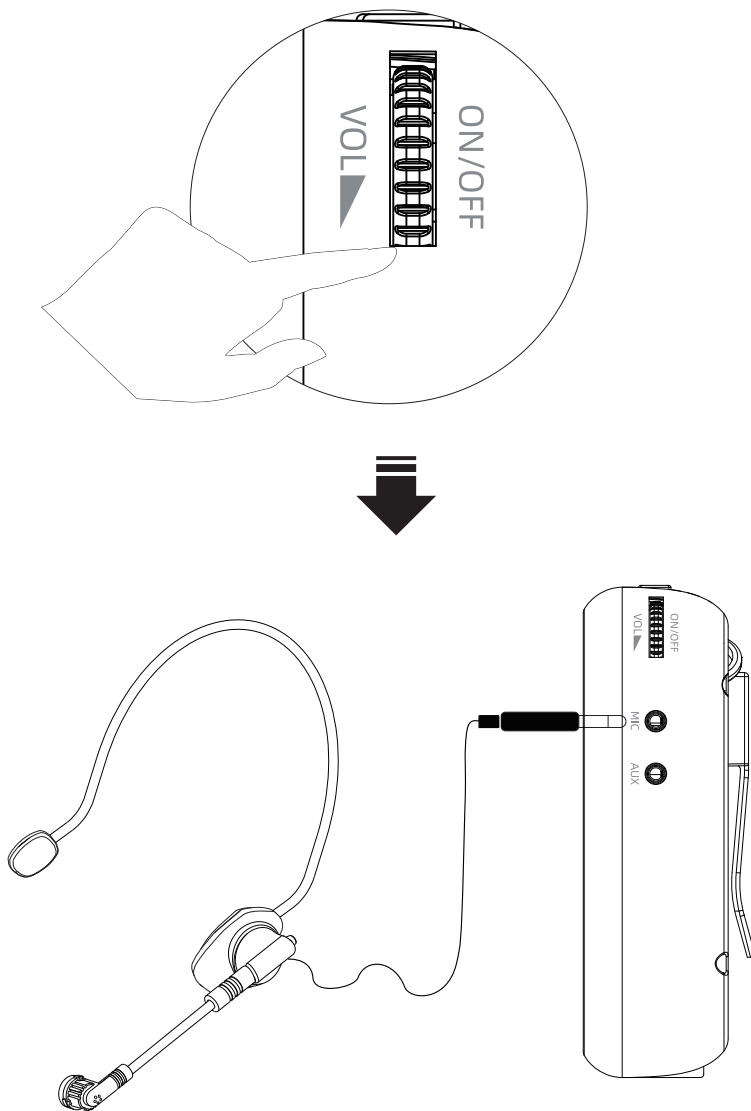





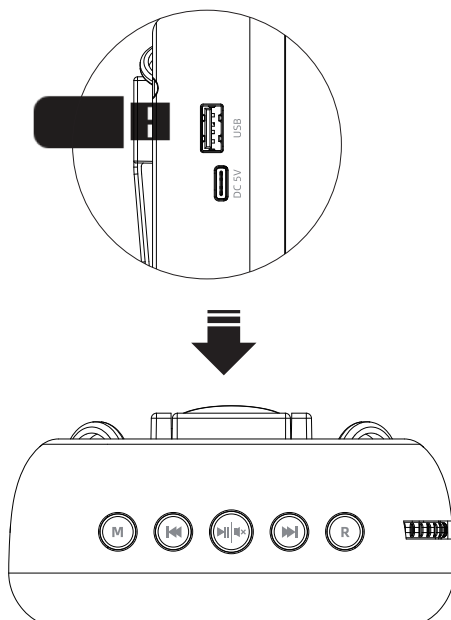

2. How to play music via U Disk

- Insert U Disk into the USB slot, speaker will play music automatically.
- Short press "⏮" to switch to the next song, short press to "⏪" switch to the previous song; the screen will display the title number first, and then show play time.
- When the U disk is inserted, it will automatically switch to "USB" mode. In the "USB" mode, long press the "⏸" button to switch to Single loop or All loop, the screen will display "OnE" (single loop) or "ALL" (all loop)

Noted: U Disk is NOT included;



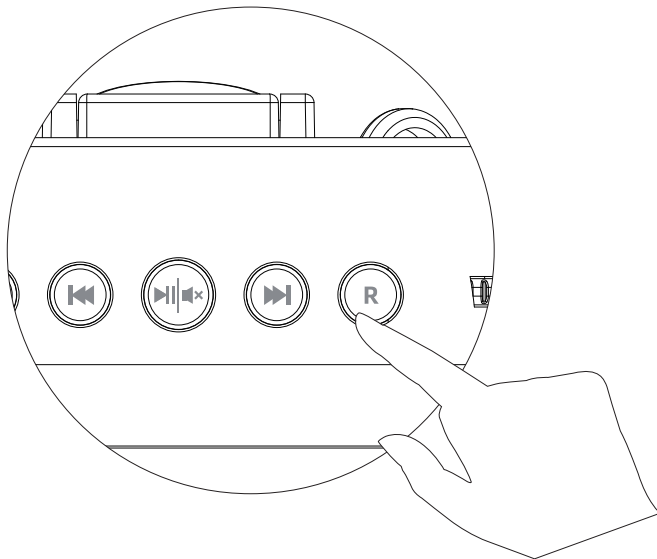

3. How to play recording

- After inserting the U disk, short press the "  "button to start recording, the bottom of the screen displays "REC" flashing.
- The recording time (such as 00:01) is displayed in the middle of the screen. Short press the "  "button to return to the current playback status.
- The recording file is saved in the U disk. Long press the "  "button to play the recording file, and press the "  "and "  "buttons to switch to the previous recording file and next recording file.
- Short press the "  "button or short press the "  "button to quit recording.



4. How to play music via AUX input

- Connect speaker to external audio device (with 3.5mm audio output like computer) via audio cable included;
- Plug in an **AUX** cable, **S208** will automatically switch to **AUX** mode, the screen will displays " **AUX** ". If there will also be music playing, short press the "  "button, S208 will pause playing and muted. And short press the "  " button again to resume music playing.

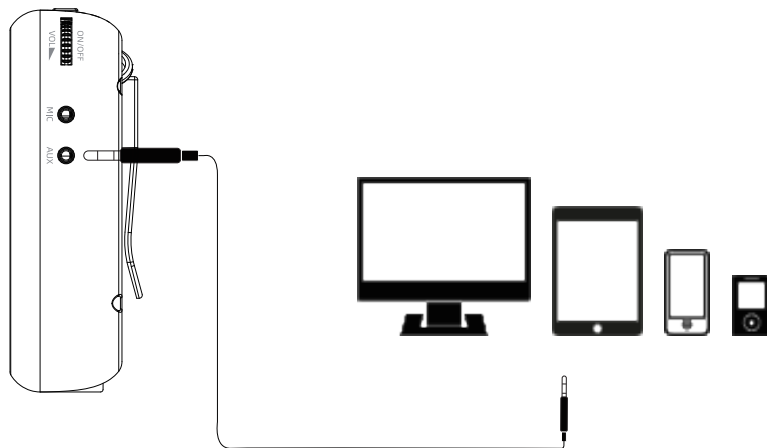

5. How to play music via Bluetooth

- Press the "  "button to switch to the Bluetooth mode, when the Bluetooth is not connected, the screen displays "**bLUE**" and flashes, and it will enter Bluetooth pairing mode automatically.
- Turn on the Bluetooth of your Bluetooth devices, find the device with the Bluetooth name S208 in the list, click connect. After the pairing is successful, the "**bLUE**" on the screen will keep on, and there will be a successful connection prompt.

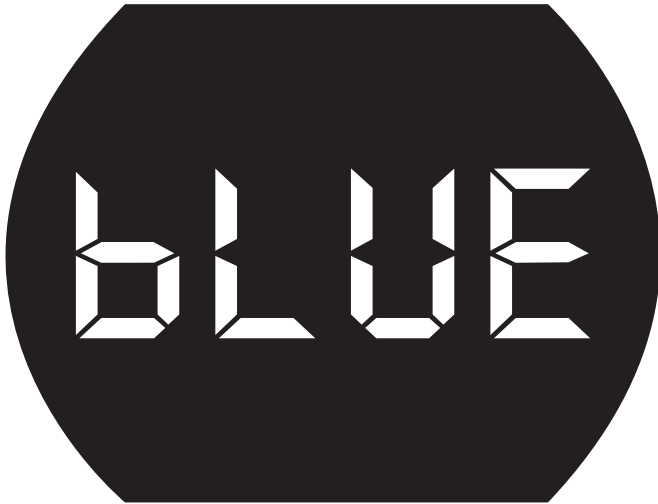

6. How to charge the speaker

- When the battery is lower than 20%, a low battery mark will flash on the screen.
- When the battery is charging, the indicator light keeps constant red.
- When the battery is full, the indicator light keeps constant green.

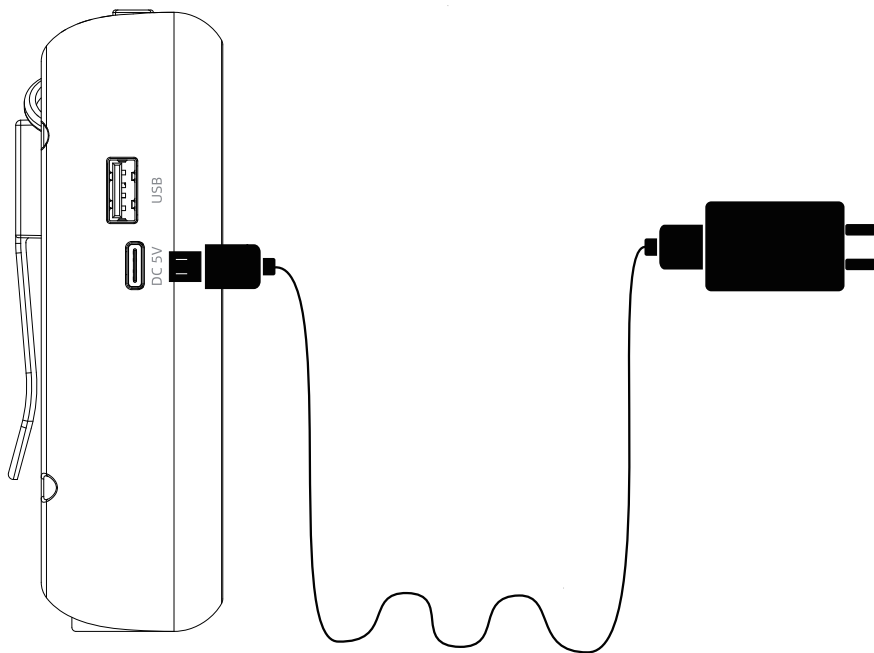

Please note:

1. Please use a DC 5V power adapter to charge the speaker (Charging adapter is not included).
2. Plug adapter into 110~240 AC outlet. Connect the cable end into the DC 5V power input on speaker.
3. It will normally take 3 hours to fully charge the battery.
4. When charging, the indicator light keeps constant red, and when it is full, it keeps constant green.
5. In order to extend the life of the internal battery, please charge it regularly even if system is not being used.
6. Please DO NOT over charge the battery by leaving the system plugged in continuously. This will reduce the life of the internal rechargeable battery and could cause over heating.

Specifications

Output power	10W	Frequency reponse	20Hz-20KHz
Battery capacity	1800mAh	Charging time	3H
Music playing time	6H-8H (medium volume)	Amplifying voice time	8H-10H



How to wear voice amplifier unit:

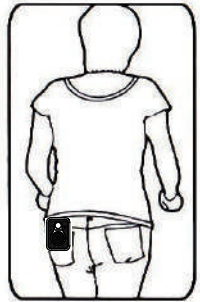
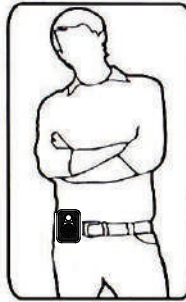

FCC Warning:

Any Changes or modifications not expressly approved by the party responsible for compliance could void the user's authority to operate the equipment.

This device complies with part 15 of the FCC Rules. Operation is subject to the following two conditions:

- (1) This device may not cause harmful interference
- (2) this device must accept any interference received, including interference that may cause undesired operation.

Note:

This equipment has been tested and found to comply with the limits for a Class B digital device, pursuant to part 15 of the FCC Rules. These limits are designed to provide reasonable protection against harmful interference in a residential installation. This equipment generates uses and can radiate radio frequency energy and, if not installed and used in accordance with the instructions, may cause harmful interference to radio communications.

However, there is no guarantee that interference will not occur in a particular installation. If this equipment does cause harmful interference to radio or television reception, which can be determined by turning the equipment off and on, the user is encouraged to try to correct the interference by one or more of the following measures:

- Reorient or relocate the receiving antenna.
- Increase the separation between the equipment and receiver.
- Connect the equipment into an outlet on a circuit different from that to which the receiver is connected.
- Consult the dealer or an experienced radio/TV technician for help.

The device has been evaluated to meet general RF exposure requirement. The device can be used in portable exposure condition without restriction.

Package included:

- 1* speaker
- 1* headset microphone
- 1* waistband
- 1* charging cable
- 1* audio cable
- 1* user manual



After-sale service

WinBridge provides one year warranty and lifetime technical support.



info@winbridgepower.com

<http://www.wwinbridge.com>



Please be confident that seller support is just a mail away from you in case you find any difficulty. Kindly do not hesitate to write back to us if you need any clarification or any kind of support.