

PORTABLE PA SYSTEM

USER MANUAL

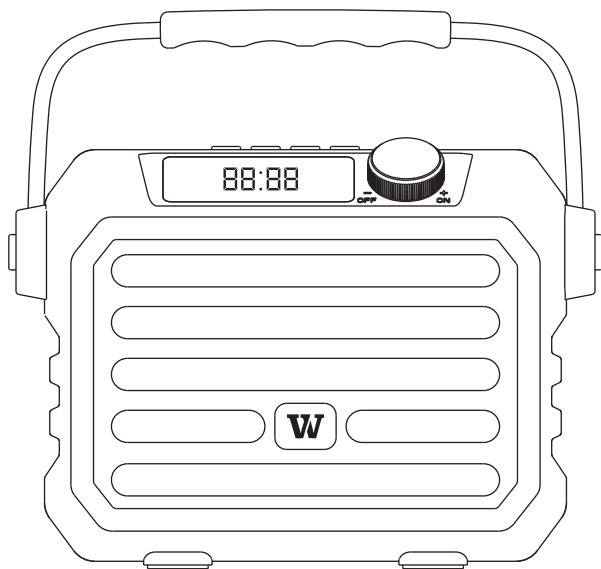

H 5

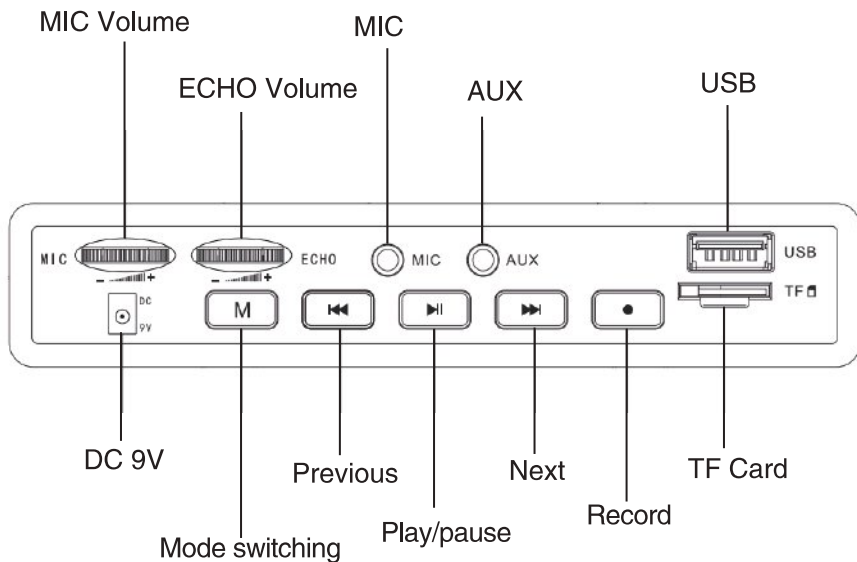

M : Press one time to switch modes among UHF, Bluetooth, FM and USB drive play; (If you plug USB drive)

⏮ : Previous

⏭ : Next

⏸ : Pause/Resume; Under any mode, Double click to turn on/off voice prompt, there will be a “Di” sound.

🔊 : Turn on/off speaker; Control music volume;

⏺ : Long press to start to recording; Short press to play recording or switch to play USB drive/TF card music.

Function Illustration (Wireless MIC):.....

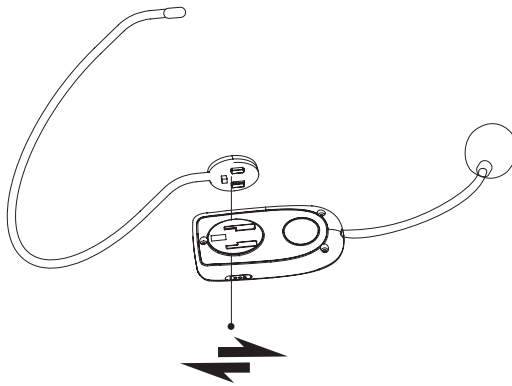
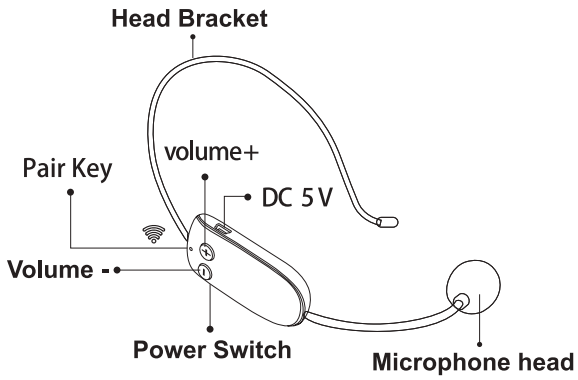

Detachable Head Bracket

How to disassemble the wireless mic:



MODES

initial

00:00

TF/micro SD card

Sd

mic input only

UHF

bluetooth

BLUE

USB flash drive

USB

recording

REC

audio cable input

AUX LINE

FM radio

106.9 FM

Press **M** to change mode (except Recording mode).

How to Pair Wireless Microphone with Speaker?

- 1 Turn on U8 wireless microphone with Blue light becomes constantly lights.



- 2 Turn on speaker, short press M button to switch to UHF mode with screen shows: **UHF**, then long press M button again for 3 seconds to enter UHF pairing mode with voice prompt: **“UHF is waiting for connection...”**, meanwhile UHF indicator become flashes.
- 3 Do a press on the small silicone button wifi on the mic until speaker prompt: **“UHF is connected”**, then you could start to enjoy it.

Noted: When connected, by long press wifi button on the mic or long press the M button on the speaker would disconnect with speaker. Please refer above steps to re pair mic with speaker manually again.

How to Play FM ?

- 1 Click **M** to switch to FM mode with a screen shows like **106.9** , and there will be voice prompts: FM Mode

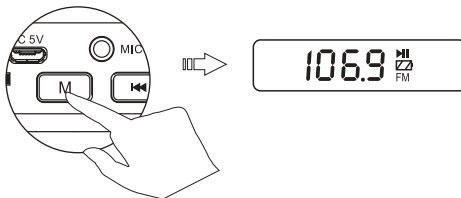

- 2 Long press **▶||** for about 3s to start automatic channel search
The search will last about 1 min, just leave it before it's done.
There will be several or dozens of channels. (The amount depends on the area.)
Each channel is given a sequence number (in ascending order of frequency)
For example, **106.9** = Channel 3
- 3 Click **◀▶** to play previous/next channel;

How to Play Recording ?

Prerequisite: require a USB drive or TF card for storage and a microphone for input.

- 1 Under any mode, long press (3s) **●** button to start recording;
There will be a voice prompts **"Start recording."**
And the screen shows like this **00:01**
- 2 Connect with wireless mic or plug in an external wired mic to talk with it.
- 3 Click **●** button to finish and save recording; At this point, it will play recording file automatically you just made;
Please click **▶||** button to pause/resume;
Click **◀▶** to play previous/next recording;
Click **●** again to play USB drive/TF card music.
- 4 Click **M** button to quit recording and switch to other modes;

Music Play

Supports:

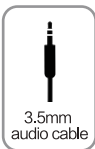
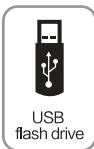

Refer to

MODES

How to Connect Bluetooth ?

- 1 Click **M** to switch to Bluetooth mode with a screen shows **BLUE**, and there will be voice prompts:

Bluetooth is waiting for connection;

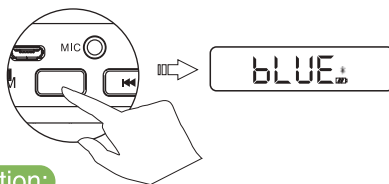

- 2 Turn on Bluetooth device and search named "H5" to pair.

How to Play TWS ?

- 1 Turn on two H5 speakers, click **M** button to enter Bluetooth mode, long press one of speaker's M button to enter pairing status, the other one Bluetooth indication become solid lights means these two speakers are connected successfully.
- 2 Turn on your phone or Bluetooth device and search named "H5" to pair.

How to Play Aux

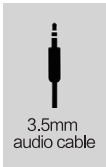

plug the 3.5mm audio cable into the AUX hole.

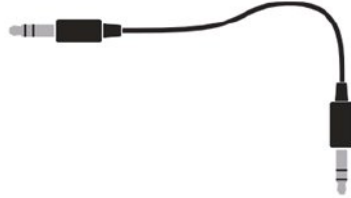

————— connect to any device with 3.5mm audio output —————

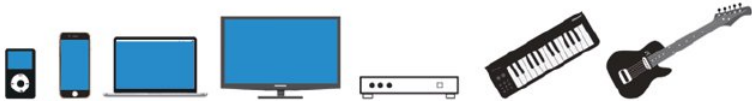

Audio Format supported:

MP3

WAV

WMA

APE

FLAC

How to Play USB drive or TF card

Just connect a USB drive or TF card, then speaker will play music automatically. Please make sure your USB or TF card have music files.

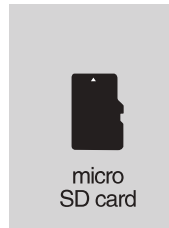
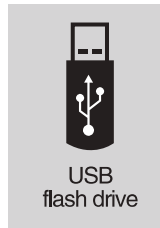

HOW TO CHARGING SPEAKER?

—— When working (but not charging) ——

Enough Power indication: the battery sign on the screen normally on 

Low Power indication: the battery sign on the screen Blinks 

—— Charging speaker with plug included ——

In charging status: the indicator  flashes while charging;

Fully charged: the indicator  turn on solid lights after charged fully.

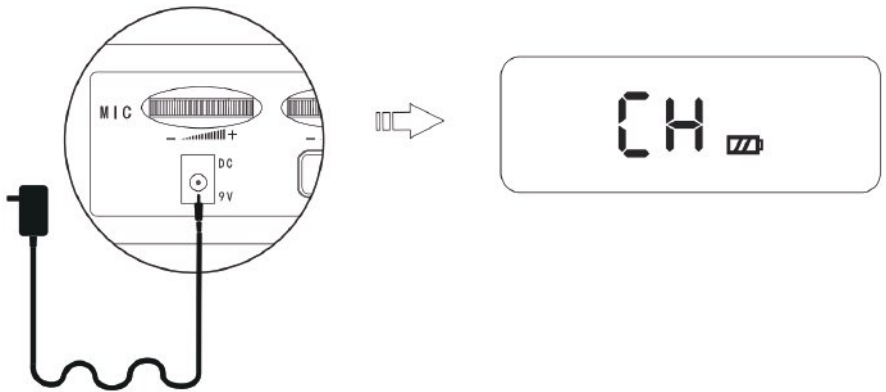

Please note:

- 1 Use the included 9V AC power adapter to charge the speaker internal rechargeable battery.
- 2 Plug adapter into 110~240 AC outlet. Connect the cable end into the DC 9V power input on speaker.
- 3 It will normally take 3~5 hours to fully charge the battery.

- 4 When charging is required, a voice prompt will indicate, “Low battery, please charge.” The battery indicator will blink while charging. It will stop blinking when battery is fully charged.
- 5 Recharge the battery within 48 hours of “low battery” voice prompt. In order to extend the life of the internal battery, please charge it regularly even if system is not being used.
- 6 It is suggested that you charge the internal battery an additional 1–2 hours after fully charged to extend its life.
- 7 Please DO NOT over charge the battery by leaving the system plugged in continuously. This will reduce the life of the internal rechargeable battery and could cause over heating.

HOW TO CHARGING MICROPHONE?.....

—— Charging speaker with plug included. ——



In charging status: the indicator shows red while charging;



Fully charged: the red indicator goes off after charged fully.



TROUBLESHOOTINGS.....

Malfunction	Possible Causes	Solution
Why speaker sound volume is lower than expected even its' volume set to maximum?	Forget to turn up U8 microphone volume;	Please short press “+” key on the U8 mic to turn up volume;
Powered on but no sound	1.Speaker no power; 2.No input source; 3.Volume set to the minimum;	1.Charge speaker; 2.Recheck the input; 3.Turn up 
Mic no sound	1.Connect lost; 2.Mic volume set to the minimum; 3.Speaker volume set to the minimum;	1.Please re connect mic with speaker follow above steps; 2.Click “+” button on the mic to turn up volume; 3.Turn Speaker VOL up 
Doesn't play music in the USB drive or TF card	1.Format not supported; 2.Program disorder; 3.Volume set to the minimum;	1.Only support MP3 WAV WMA APE FLAC; 2.Reboot speaker; 3.Turn up 
Howling	Microphone too close to speaker;	Keep distance between mic and speaker;
Microphone loose power quickly	1.Microphone isn't charged fully; 2.Forget turn off mic volume while charging or not work;	1.Please make sure your mic is charged fully before use; 2.Please remember turn off mic volume while charging or not work;
Other		Contact us

Package includes:

- 1* Bluetooth speaker
- 1* Microphone headset
- 1* Audio cable
- 1* 9V Charger
- 1* 5V Charger
- 1* Charging cable
- 1* Manual



After-sale service

WinBridge provide one year warranty and lifetime technical support.

 info@winbridgepower.com



Please be confident that Seller support is just a mail away from you in case you find any difficulty. Kindly do not hesitate to write back to us if you need any clarification or any kind of support. <http://www.winbridgepower.com>
